

LINEAR CYLINDERS

SERIES LI

▶ PRODUCT ADVANTAGES

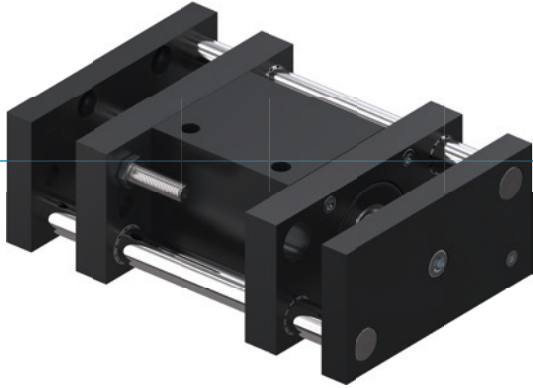

▶ Large locating flange

The large mounting surface simplifies your design and allows secure attachment of follow-on tools









▶ Dampened end position

By using PowerStop shock absorbers, you can gently move up to the end positions, increasing the process reliability and durability of your application

▶ Failure-free continuous operation

Our uncompromising “Made in Germany” quality guarantees up to 10 million maintenance-free cycles

▶ SERIES CHARACTERISTICS

Installation size	Version		
LIXX		D	S
 2 way guiding			●
 3 way guiding		●	
 Continuous piston rod		●	
 10 million maintenance-free cycles (max.)	●	●	●
 Inductive sensor	●	●	●
 Elastomer end position damping	●	●	●
 Powerstop end position damping	●	●	●
 IP 54	●	●	●



► BENEFITS IN DETAIL

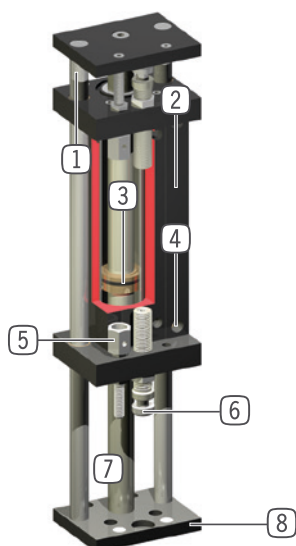

- ① **Guide rod**
 - hardened, polished steel shaft
- ② **Mounting block**
 - mounting for inductive proximity switch
- ③ **Drive**
 - double-acting pneumatic cylinder
- ④ **Energy supply**
 - reducing exhaust air is recommended
- ⑤ **End stop confirmation screw**
 - direct flange position sensing
 - included in scope of delivery
- ⑥ **End position damping**
 - with elastomer absorber or patented hydraulic shock absorber
- ⑦ **Piston rod**
 - polished, hard chrome plated steel
 - continuous in design D
- ⑧ **Intake flange**
 - for connection to application-specific adapter plate (to be supplied by the customer)

► TECHNICAL DATA

Installation size	Stroke [mm]	Pressure force max. [N]	Retraction force [N]	Weight [kg]	IP class
L116	20 - 50	80 - 100	80	0,05 - 0,1	IP54
L130	15 - 90	200 - 270	200	0,05 - 0,1	IP54
L140	40 - 300	270 - 450	270	0,05 - 0,3	IP54
L150	50 - 300	950	950	0,03 - 0,2	IP54

► FURTHER INFORMATION IS AVAILABLE ONLINE



All information just a click away at: www.zimmer-group.com. Find data, illustrations, 3D models and operating instructions for your installation size using the order number for your desired product. Quick, clear and always up-to-date.

LINEAR CYLINDERS

LI30-60 / LI30-90

▶ PRODUCT SPECIFICATIONS



▶ Forces and moments

Max allowable static forces and moments.

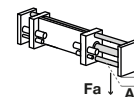

▶ RECOMMENDED ACCESSORIES



ENERGY SUPPLY



DRVM5X4
Flow Control Valves - with Swivel joint



SENSORS



NJ12-E2S
Inductive proximity switch - Connector M8



CONNECTIONS / OTHER



AP30
Adapter plate



AD-M10X1
Shock Absorbers



CONNECTIONS / OTHER



HV30
Absorber intake



PHE10X10NMDE-A
Industrial shock absorbers PowerStop



KAG500
Plug-in connector Straight Cable 5m - Socket M8 (female)



KAW500
Plug-in connector Angled Cable 5m - Socket M8 (female)



ZE20H7X4
Centering Disc

Order no.	► Technical data	
	LI30-60	LI30-90
Stroke [mm]	60	90
Pressure force max. [N]	270	270
Retraction force [N]	200	200
Travel time without external load [s]	0.25	0.26
Nominal operating pressure [bar]	6	6
Operating temperature min. [°C]	5	5
Operating temperature max. [°C]	+80	+80
Air volume per cycle [cm ³]	50	92
Weight [kg]	0.47	0.58
Load Fa max. [N]	30	20
Max. deflection A [mm]	0.05	0.05

